

Approval acc. to ATEX

Description

- Pressure switches 2 ... 32 bar with perbunan diaphragm.
- Pressure switches 60 ... 250 bar with plastic plunger and throttle.
- Throttle must be removed when using viscous media.



Control pressure switch FF 4-4 AB DAH

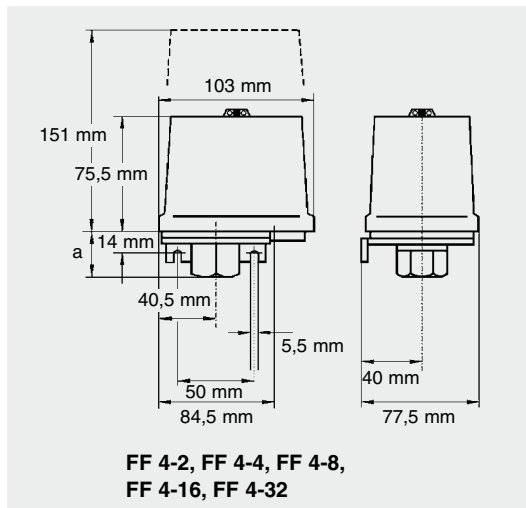

Control pressure switch FF 4-4 AC DAH

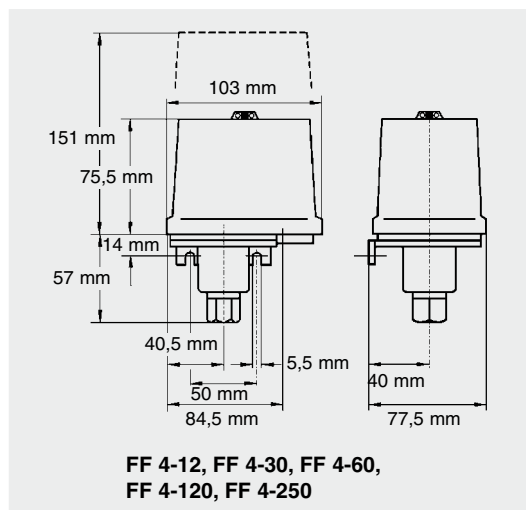

Types

Protection class: IM2 Ex ia IMb, Pressure connector: H (G 3/8" Female thread)

Order reference	Upper switch pt. adjustable (bar)	Lower switch pt. adjustable (bar)	Smallest diff.* (bar)	Max. operating pressure (bar)	Max. test pressure (bar)	Standard setting (bar)	Part No.
FF 4-2 AB DAH	0,11 ... 2	0,04 ... 1,89	0,07 0,11	20	40	0,5 / 1,5	1030133
FF 4-4 AB DAH	0,22 ... 4	0,07 ... 3,75	0,15 0,25	24	40	1 / 3	1030134
FF 4-8 AB DAH	0,5 ... 8	0,2 ... 7,5	0,3 0,5	30	40	2 / 6	1030135
FF 4-16 AB DAH	1 ... 16	0,4 ... 15	0,6 1	36	48	4 / 12	1030136
FF 4-60 AB PAH	8 ... 60	4 ... 52	4 8	100	120	20 / 40	1030138
FF 4-120 AB PAH	16 ... 120	8 ... 104	8 16	200	240	20 / 80	1030139
FF 4-250 AB PAH	30 ... 250	14 ... 226	12 24	400	500	100 / 200	1030140

* at lower ... higher end of range

Types

Protection class: II 2G Ex ia IIC T6 Gb, Pressure connector: H (G 3/8" Female thread)

Order reference	Upper switch pt. adjustable (bar)	Lower switch pt. adjustable (bar)	Smallest diff.* (bar)	Max. operating pressure (bar)	Max. test pressure (bar)	Standard setting (bar)	Part No.
FF 4-2 AC DAH	0,11 ... 2	0,04 ... 1,89	0,07 0,11	20	40	0,5 / 1,5	1030141
FF 4-4 AC DAH	0,22 ... 4	0,07 ... 3,75	0,15 0,25	24	40	1 / 3	1030142
FF 4-8 AC DAH	0,5 ... 8	0,2 ... 7,5	0,3 0,5	30	40	2 / 6	1030144
FF 4-16 AC DAH	1 ... 16	0,4 ... 15	0,6 1	36	48	4 / 12	1030145
FF 4-32 AC DAH	2 ... 32	0,8 ... 30	1,1 2	52	64	10 / 20	1030146
FF 4-60 AC PAH	8 ... 60	4 ... 52	4 8	100	120	20 / 40	1030147
FF 4-120 AC PAH	16 ... 120	8 ... 104	8 16	200	240	20 / 80	1030149
FF 4-250 AC PAH	30 ... 250	14 ... 226	12 24	400	500	100 / 200	1030150

* at lower ... higher end of range

Types

Protection class: II 2G Ex ia IIC T6 Gb, Pressure connector with stainless steel corrugated bellows,

Pressure connector: G (G 1/4" Female thread)

Order reference	Upper switch pt. adjustable (bar)	Lower switch pt. adjustable (bar)	Smallest diff.* (bar)	Max. operating pressure (bar)	Max. test pressure (bar)	Standard setting (bar)	Part No.
FF4-12 AC AAG	1 ... 12	0,5 ... 11,2	0,5 0,8	12	16	6 / 7	1030131
FF4-30 AC AAG	4 ... 30	1 ... 26,4	1,8 3,6	30	42	16 / 20	1030132

* at lower ... higher end of range

Technical data

Resistance to vibration 10 up to 1000 Hz	4 g
Protection acc. to DIN 40 050/IEC 529 with rubber grommet	IP 54
Protection acc. to DIN 40 050/IEC 529 with cable glands PG 13.5/M20	IP 65
Ambient temperature range	-30 ... +60° C
Perm. medium temperature (...DAH, PAH)	+70° C
(...AAG)	+200° C
Repeatability	< 2 % FS

Accessories

Order reference	Description	Weight (g)	Part No.
Throttles			
Throttle FF4-2 ... 32	Throttle for series FF4-2 up to 32	3	1090401002
Throttle FF4-60 ... 250	Throttle for series FF4-12/30/60/120/250 (stainless steel)	3	1090401003
Glands			
H 124-114	Steel gauge fitting, G 3/4" - G 1/2"	180	1090501004

Dimensions

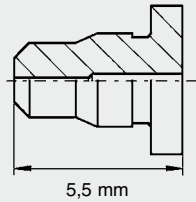

Throttle for FF 4-2 up to 32

weight: ~ 3 g
Order No.: 1011002

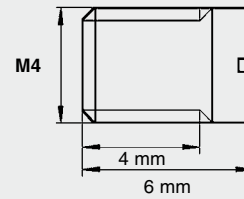

Throttle screw for FF 4-12/30/60/120/250

weight: ~ 3 g (stainless steel)
Order No.: 1011003



Switch amplifier TS-500 Ex
see page 169



Zener barrier MTL 7787+
see page 175

Circuit diagram

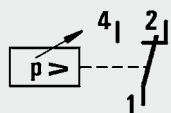

Change-over contact

Approval acc. to ATEX

Pressure diagrams

Charts show the smallest adjustable differential.

Example per figure FF 4-4: If upper setting is at 3.25 bar, lower setting can be adjusted between 0.07 and 3.0 bar (see arrows in the drawing).

FF 4-2

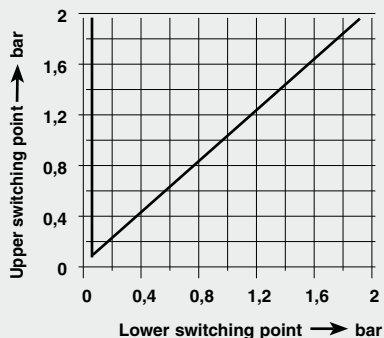

FF 4-4

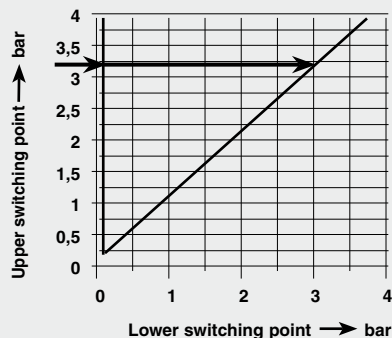

FF 4-8

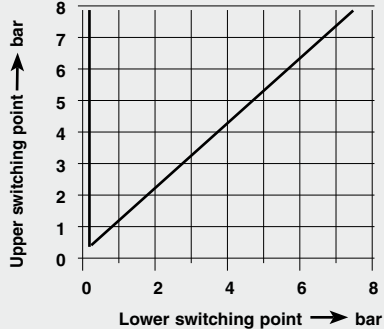

FF 4-12

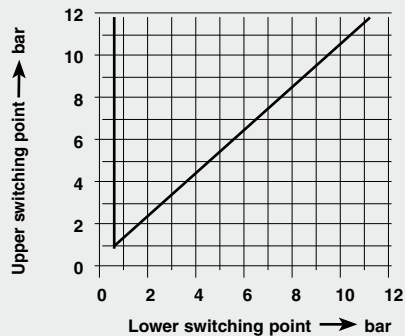

FF 4-16

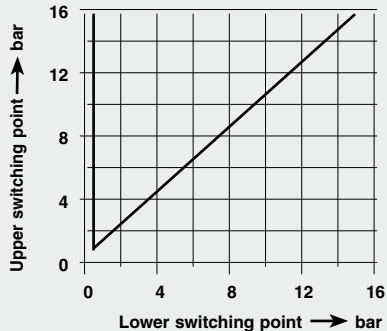

FF 4-30

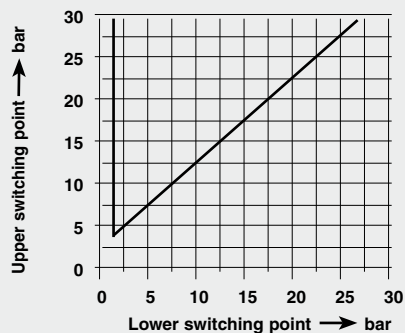

FF 4-32

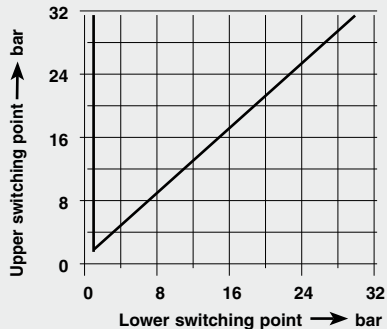

FF 4-60

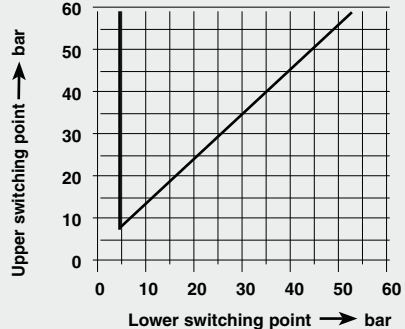

Pressure diagrams

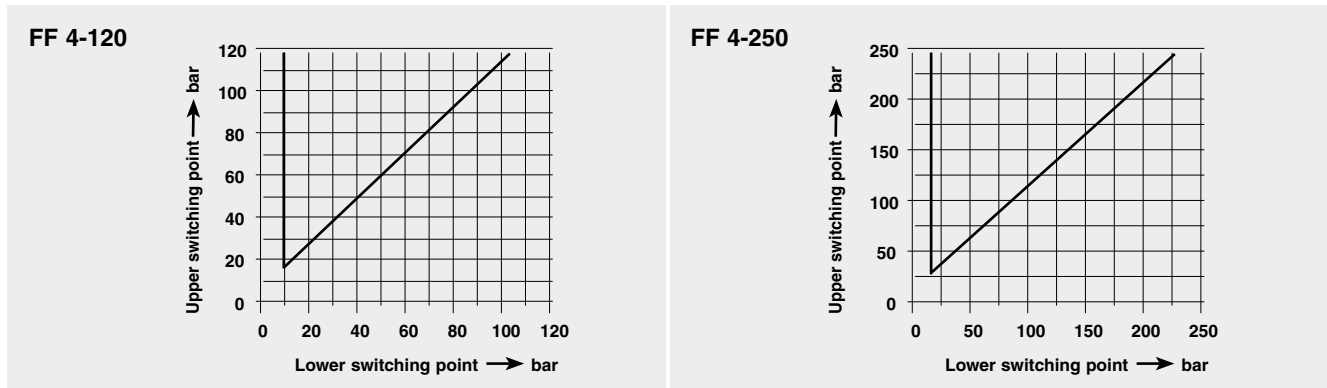

Media compatibility guide

Medium name	Chemical Formula	Stainless steel	Perbunan	Viton	Plastic
Acetone	CH ₃ COCH ₃	X			
Acetylene	HC = CH	X	X	X	X
Air	-	X	X	X	X
Benzene	Sulphur-free	X		X	
Butane	C ₄ H ₁₀	X	X	X	X
Butyl acetate	CH ₃ COOC ₄ H ₉	X			
Butyl alcohol	CH ₃ -CH ₂ -CH ₂ -CH ₂ -OH	X			
Carbon dioxide	CO ₂	X	X	X	X
Carbonic acid	H ₂ CO ₃	X	X	X	X
Chlorine	Cl ₂			X	
Crude oil	-	X	X	X	X
Diesel oil	See fuels	X	X	X	X
Ethyl acetate	CH ₃ OOOC ₂ H ₅	X			
Fuels	Diesel oil, Leaded petrol Benzene	X X X	X X X	X X X	X X X
Glycerine	CH ₂ OH-CHOH-CH ₂ OH	X	X	X	X
Glycol	CH ₂ OH-CH ₂ OH	X	X	X	X
Heating fuel oil	See also oils	X	X	X	X
Hydrogen	H ₂	X	X		X
Inert gases	-	X			
Methanol	CH ₃ OH	X			
Methyl chloride	CH ₃ Cl	X			
Natural gas	-	X	X	X	X
Nitrogen	N ₂	X	X	X	X
Oils	Mineral	X	X	X	X
Oils	Vegetable	X	X	X	
Oxygen	O ₂	X		X	
Ozone	-	X		X	
Perchlorethylene	CCl ₂ =CCL ₂	X		X	
Petrol	All types	X		X	
Phenolic acid	C ₆ H ₅ (OH)	X			
Sulphur dioxide	SO ₂	X		d	
Toluene (Metyl benzene)	C ₆ H ₅ CH ₃	X		X	
Trichlorethene	CHCl=CCl ₂	X		X	
Water	Steam / vapor	X	X	X	
Water	Distilled, de-aerated	X	X	X	X
Water	Sea water	X	X		
Xylene	C ₆ H ₄ (CH ₃) ₂	X		X	

X = recommended, d = dry